

HEAVY DUTY MIRROR J-BRACKET

INSTALLATION INSTRUCTIONS:

- Decide the appropriate place to site the mirror to give maximum vision.
- Fix J-Bracket to a wall, ceiling or pillar using suitable fixing hardware (ie: screws, bolts). Allowing enough room to get the mirror on to the J-Bracket.
- Remove Adaptor from J-Bracket and thread into the back of the mirror.
- Make sure the ventilation hole is at the lowest point for drainage (acrylic mirror only).
- Peel protective film off around the immediate edge of the mirror (acrylic mirror only).
- Slide the adaptor and mirror over the J-Bracket and adjust mirror to the desired position.
- Tighten the locking bolt on the adaptor securely.
- Totally remove the protective film from the mirror face (acrylic mirror only).

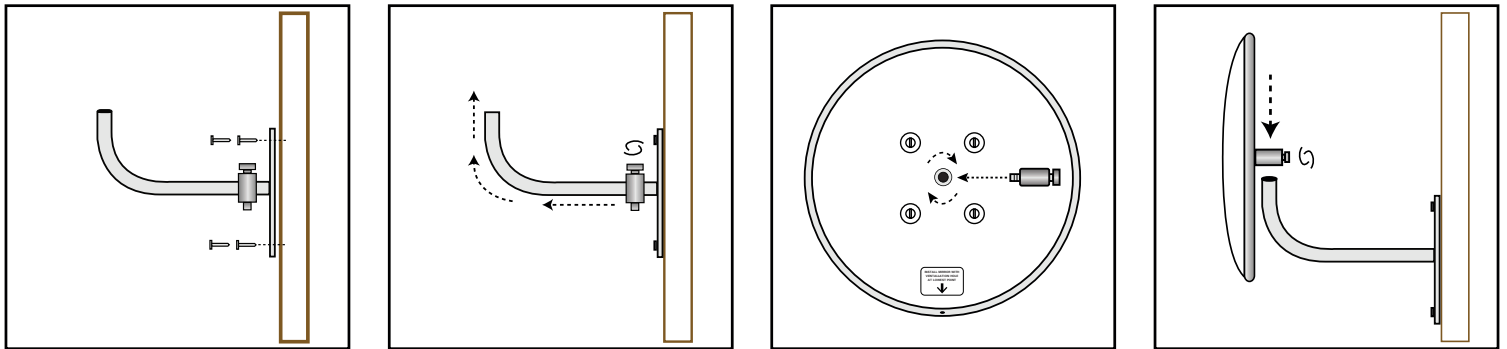



INSTALLATION:

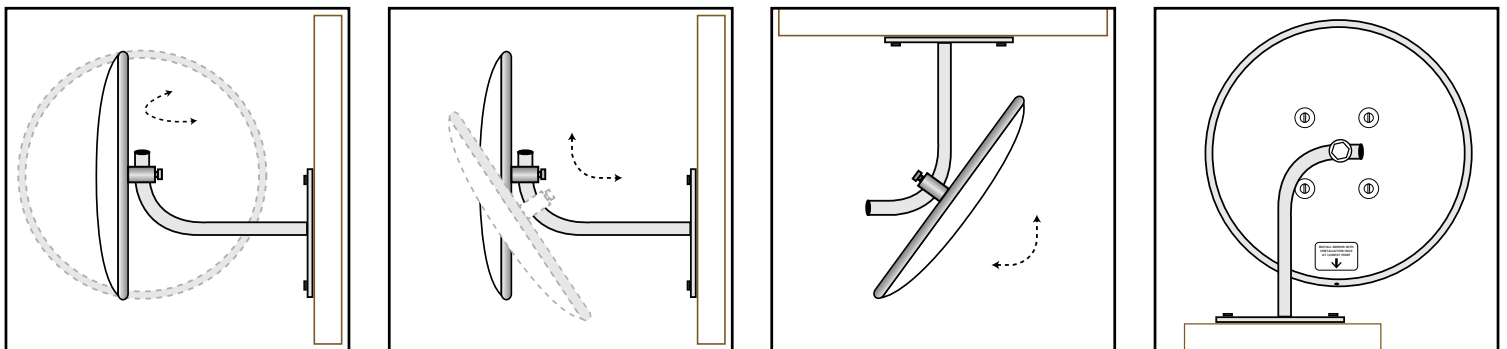

ANGLE and POSITION:



SOCIAL MEDIA

-  Duravision
-  Benmirr1
-  duravision_convex_mirrors
-  bennett-mirror-technologies



CONTACT US

PO Box 2163, Tauranga
New Zealand
T: +64 7 9285380
E: mirrors@bmt.nz
www.duravision.net



5 YEAR WARRANTY

Manufactured using the highest quality materials to provide a higher level of safety and longer lasting products

HEAVY DUTY MIRROR - WITH U-BOLTS

60mm AND 75mm U-BOLT ASSEMBLY:

U-Bolt Position For 60mm or 75mm Wide Mounting Plate (Heavy Duty Mirror Size: 300mm - 760mm)

- Position U-Bolts around the pole and AROUND the J-Bracket.
- Thread U-Bolts through both sides of Flat plate.
- Thread the washers and nuts onto the U-Bolts loosely.
- Position the J-Bracket, then tighten the nuts.

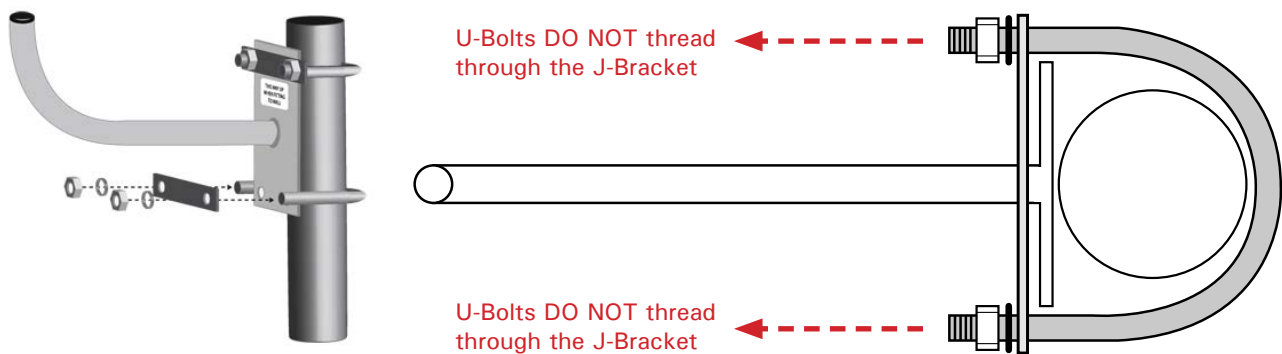



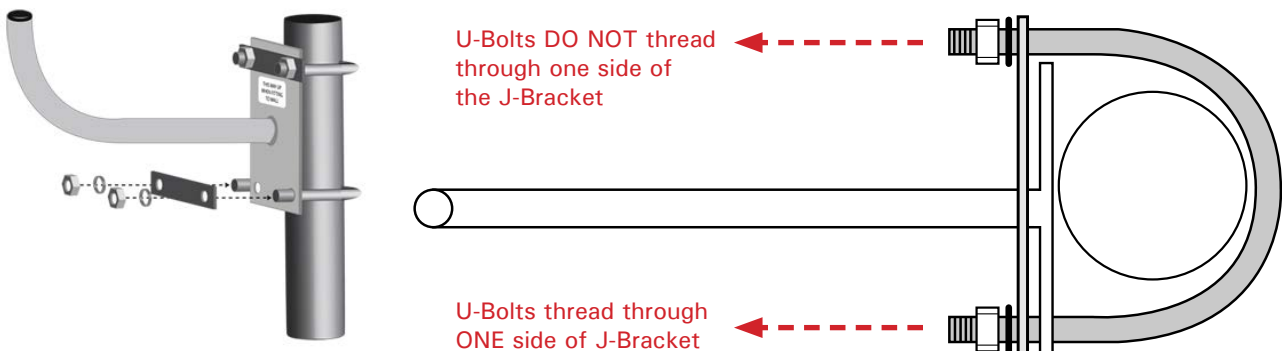

U-Bolt Position For 100mm Wide Mounting Plate (Heavy Duty Mirror Size: 800mm - 1200mm)

- Position U-Bolts around the pole.
- Thread U-Bolts through **ONE SIDE** of the J-Bracket
- Thread through both sides of the Flat plate.
- Thread the washers and nuts onto the U-Bolt loosely.
- Position the J-Bracket, then tighten the nuts.



SOCIAL MEDIA

-  Duravision
-  Benmirr1
-  duravision_convex_mirrors
-  bennett-mirror-technologies



CONTACT US

PO Box 2163, Tauranga
New Zealand
T: +64 7 9285380
E: mirrors@bmt.nz
www.duravision.net



5 YEAR WARRANTY

Manufactured using the highest quality materials to provide a higher level of safety and longer lasting products

HEAVY DUTY MIRROR - WITH STRAPPING

STEEL STRAPPING FOR EXTRA LARGE POLE:

DuraVision™ Heavy Duty Mirrors can be fixed to an extra large pole such as lamp posts, power poles and street lights using steel strapping. Place 2 - 3 straps around the pole and across the J-Bracket's mounting plate and tighten.

Purchase steel strapping from hardware stores or road sign companies.

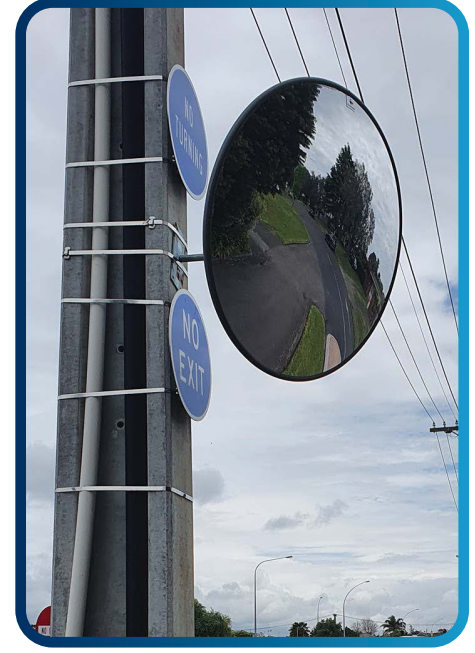
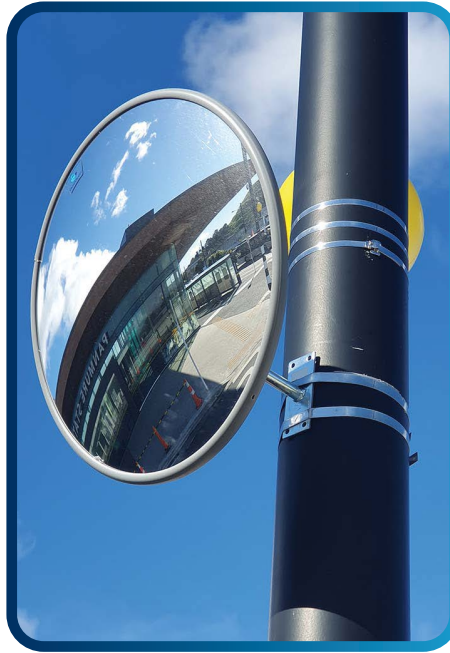

SOCIAL MEDIA

-  Duravision
-  Benmirr1
-  duravision_convex_mirrors
-  bennett-mirror-technologies



CONTACT US

PO Box 2163, Tauranga
New Zealand
T: +64 7 9285380
E: mirrors@bmt.nz
www.duravision.net



5 YEAR WARRANTY

Manufactured using the highest quality materials to provide a higher level of safety and longer lasting products